

SCANDI CORNER SOFA - U

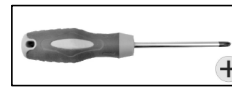

#	QUANTITY
1	1
2	1
3	2
4	1
5	2
6	4

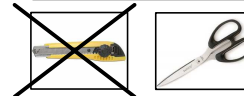
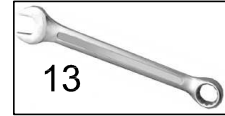
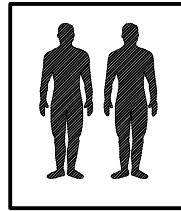
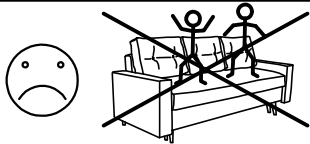
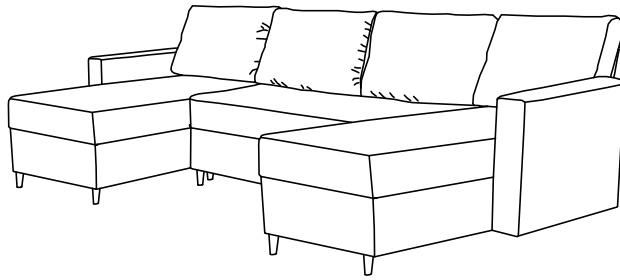
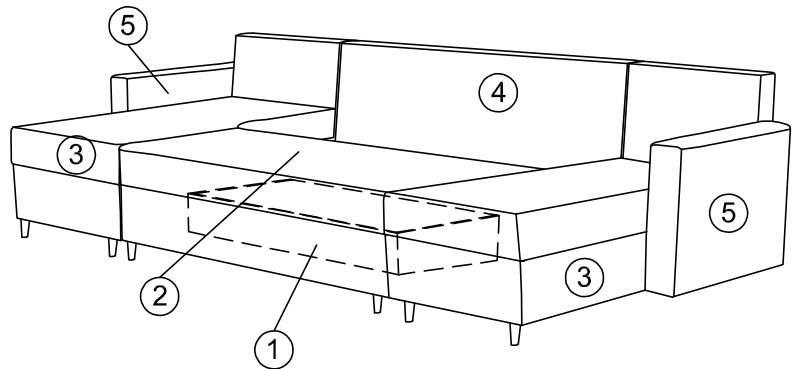
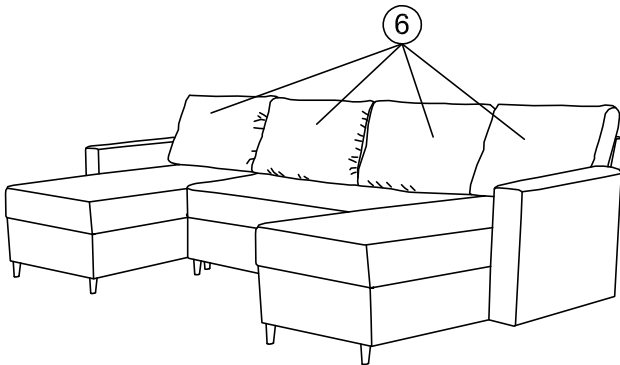
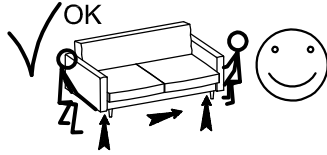
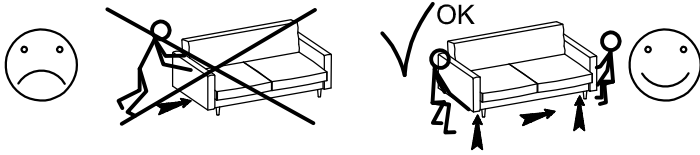

M8.0x70mm A	M8.0x70mm B	C	3.5x35mm D
4	4	14	6

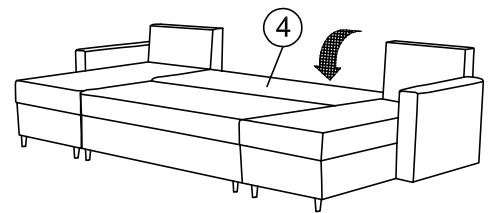
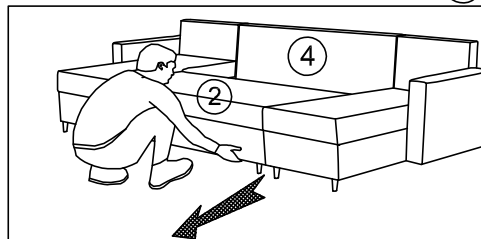

1

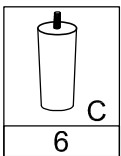

⚠ "P"- FRONT

